

Critical Velocities for Smoke Control in Tunnel Cross-Passages

Fathi Tarada, HBI Haerter Ltd., Consulting Engineers, Switzerland

ABSTRACT

This paper addresses the issue of critical flow velocities required to stop the ingress of smoke into tunnel cross-passages used for passenger evacuation. Current engineering practices for estimating critical velocities in tunnels (empirical correlations, phenomenological methods, Computational Fluid Dynamics) are briefly reviewed. The paper proposes a correlation for the critical velocity in cross-passages, and presents supporting evidence for the correlation using CFD. In addition to the usual geometrical and fire heat release parameters, the longitudinal velocity through the tunnel is found to be an important parameter for the estimation of the critical velocity through a cross-passage. Some of the assumptions and limitations of the proposed model are discussed, and practical recommendations for preliminary design work are given.

1 INTRODUCTION

During a fire scenario in a vehicle tunnel, it is of paramount importance to maintain escape routes free from dangerous smoke. In many road, railway and metro tunnels, cross-passages between two parallel tunnels are employed as escape routes during a fire emergency. These cross-passages must be guaranteed free of smoke in order to provide a visual indication of safe evacuation paths to escaping passengers, to protect passengers while they are traversing the cross-passages, and to ensure that the non-incident tube is kept clear of smoke. One important question that tunnel ventilation specialists and other parties concerned with tunnel safety have to answer is: what is the minimum fresh air velocity required to maintain smoke-free conditions in a cross-passage? The accurate estimation of this 'critical velocity' allows a better balance to be struck between the desired safety level and the cost of ventilation installations (fans, doors, ducting etc). In order to discuss the underlying issues and challenges behind this question, a review of the current practice in estimating critical velocities for smoke control is presented, followed by a discussion regarding how the particular issue of critical velocities through cross-passages can be handled.

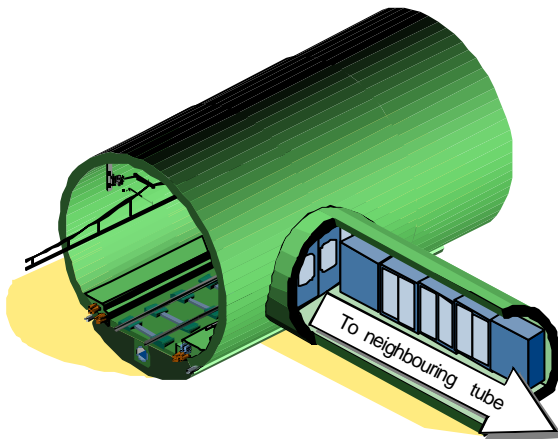

Paper presented at the First International Conference on Major Tunnel and Infrastructure Projects, 22-24 May 2000, Taipei, Taiwan.

Fig. 1: Typical Rail-Tunnel Cross-Passage (courtesy of AlpTransit Gotthard AG)

2 NOMENCLATURE

Symbol	Meaning	Units
A	Tunnel cross-sectional area	m ²
C _p	Heat capacity of air	J/(kg K)
grade	Gradient of tunnel	%
G	Acceleration due to gravity	ms ⁻²
H	Height of tunnel cross-section	m
\dot{Q}_c	Heat release rate due to fire	W
T	Temperature	K
V	Flow velocity	ms ⁻¹

Greek

ρ	Density	kg/m ³
--------	---------	-------------------

Subscripts

(none)	Ambient conditions
c	Critical value
d	Cross-passage door
f	Fire conditions
T	Main tunnel

3 SAFETY FEATURES

Before discussing the specific issue of critical velocities in cross-passages, it may be of benefit to outline the general safety features applicable to tunnel cross-passages used for evacuation purposes, as outlined in approximate chronological order below:

Immediately after fire incident in a vehicle

Cross-passages are usually protected at one or both sides by doors which act as passive fire and smoke barriers. These doors are designed to withstand high temperatures (204 °C according to NFPA 105, 1993) during the entire evacuation period.

Upon activation of the emergency ventilation system

A positive pressure difference is developed across the cross-passage. Fresh air flows across any cross-passage openings and leakages from the non-incident to the incident tube (Fig. 2). However, the pressure difference must be limited in order to facilitate manual opening of the doors (133 N maximum force according to NFPA 92A, 1996).

After opening the cross-passage doors

The cross-passage doors in the region of the fire are opened either manually by escaping passengers or staff, or via remote control from the traffic operations centre. Due to the reduced flow resistance, the air-flow in the direction of the incident tube is significantly increased, and this serves to block the flow of smoke into the cross-passage. In addition, a ‘bubble-effect’ is generated in the incident tube, where the fresh air jet clears the smoke in the vicinity of the cross-passage door and thus serves to direct

escaping passengers. This effect was observed during the Channel Tunnel fire (Channel Tunnel Safety Authority, 1997).

We shall now focus on the issue of estimating the critical velocity for smoke control after opening the cross-passage doors.

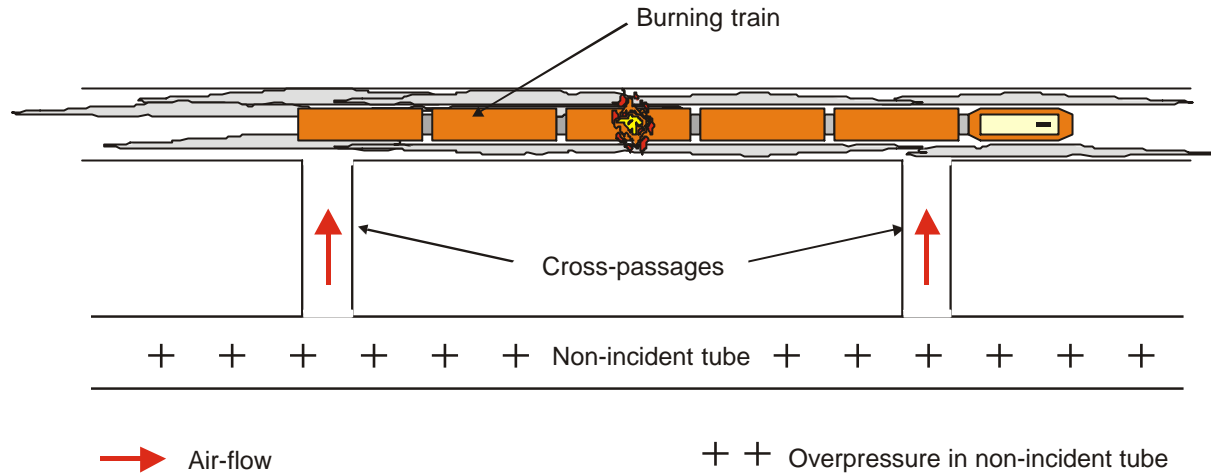

Fig. 2: Emergency Ventilation across Rail Tunnel Cross-Passages

4 CURRENT PRACTICE IN ESTIMATING THE CRITICAL VELOCITY

Current engineering practices for calculating the critical velocity for smoke control in tunnels include:

Empirical correlations

The most widely-used correlations for estimating the critical velocity are based upon a non-dimensional Froude number analogy (Thomas, 1970). The Froude number is defined as the ratio between the buoyancy forces generated by the fire and the inertial forces due to the imposed ventilation air flow (Eqn. 1).

$$Fr = \frac{gH(\mathbf{r} - \mathbf{r}_f)}{\mathbf{r}V^2} \quad \text{Eqn. 1}$$

According to the experimental measurements of Lee et al (1979), Froude numbers of less than 4.5 are required to preclude the movement of smoke against the imposed ventilation flow direction.

By relating the density difference between the hot gases from the fire to the ambient air ($\mathbf{r} - \mathbf{r}_f$) to the convective heat release rate from the fire (\dot{Q}_c), Kennedy (1996) proposed a formula for the critical velocity, such:

$$V_c = \left(\frac{gH\dot{Q}_c}{\mathbf{r}C_pAT_f Fr_c} \right)^{1/3} \quad \text{Eqn. 2}$$

where the critical Froude number (Fr_c) is given by

$$Fr_c = 4.5(1 + 0.0374|\min(\text{grade}, 0)|^{0.8})^{-3} \quad \text{Eqn. 3}$$

T_f is estimated from the enthalpy conservation equation:

$$T_f = \frac{\dot{Q}_c}{rC_pAV_c} + T \quad \text{Eqn. 4}$$

Equations 2 to 4 form a coupled set that are solved within many well-used tunnel ventilation programmes including the Subway Environmental Simulation (SES) Computer Programme (Version 4, 1997). Nonetheless, Grant et al (1998) have pointed out several methodological weaknesses in this model, including its failure to account for the complex near-fire flow field and its interaction with the fire source and the particular tunnel under consideration.

For the particular case of tunnel cross-passages, the convective heat release rate Q_c from a vehicle fire occurs *outside* the cross-passage so it is not immediately obvious how this model should be used. In addition, it is not clear which flow velocity should be used in Eqn. 4 (through the tunnel or through the cross-passage?). Section 5 proposes a development of this model to account for cross-passage flows.

Phenomenological methods

These are typically two-dimensional methods that employ multiple zones (fresh air layer, smoky layer(s)) for predicting the smoke spread from fires, as described by Charters et al (1994). Although they provide significantly more information than simple empirical correlations for the critical velocity, their extension to deal with cross-passage flow is inherently problematic due to the strong three-dimensional nature of such flows.

Computational Fluid Dynamics (CFD)

CFD is an engineering tool for solving the governing Navier-Stokes equations for the flow, temperature and flow species in virtually any system of interest. Its power and flexibility has led it to its increasing use for tunnel ventilation applications, including the resolution of the near-fire flow field (e.g. Tuovinen and Holmstedt, 1994). However, CFD offers no panacea – the underlying mathematical models relating to turbulence, combustion and radiation are still being actively developed and hence have to be carefully validated for the proposed engineering application.

Most tunnel ventilation specialists still employ one-dimensional flow networks using computer programmes such as ThermoTun or SES to develop their emergency ventilation concepts, and only use CFD to confirm their one-dimensional design or to answer critical questions (e.g. relating to three-dimensional flow and smoke patterns) that cannot be dealt with using simpler tools.

5 EMPIRICAL MODEL FOR CROSS-PASSAGE CRITICAL VELOCITY

As made apparent in the previous discussion, empirical models for the critical velocity are still of engineering interest, despite the availability of phenomenological methods and CFD. They offer a fast and robust means of estimating the required airflow, which can be used for preliminary ventilation designs. If required, more sophisticated engineering calculations or physical model tests can be carried out to confirm the final design parameters.

In order to develop the empirical model, we shall consider the enthalpy balance in a control volume straddling both the cross-passage and the main tunnel (Fig. 3).

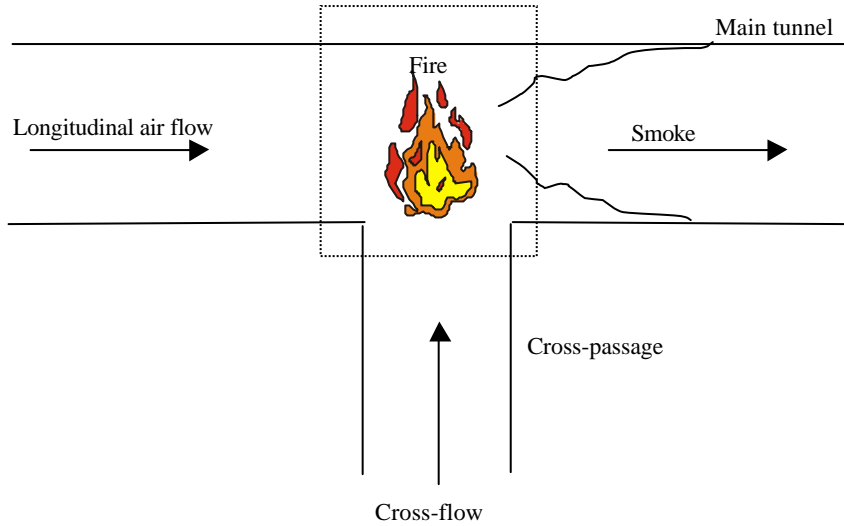

Fig. 3: Control Volume for the Enthalpy Balance in a Tunnel Cross-Passage

In the absence of appreciable conductive heat loss through the walls, the enthalpy equation for the above control volume can be written as

$$(\dot{m}C_p T)_T + (\dot{m}C_p T)_d + \dot{Q}_c = (\dot{m}C_p T_f)_T \quad \text{Eqn. 5}$$

where the subscript 'T' refers to the main tunnel, the subscript 'd' refers to the cross-passage door and all other terms are defined in the Nomenclature.

Through analogy with Eqn. 1, the Froude number at the cross-passage door may be written as

$$Fr = \frac{gH_d(\mathbf{r} - \mathbf{r}_f)}{\mathbf{r}V_d^2} = 4.5(1 + 0.0374|\min(\text{grade}, 0)|^{0.8})^{-3} \quad \text{Eqn. 6}$$

where $T_{f,T}$ is the mixed-out temperature downstream of the tunnel fire. Eqns. 5 and 6 can be solved in a coupled manner to estimate the critical velocity.

In the absence of a longitudinal flow in the tunnel ($\dot{m}_T \rightarrow 0$), equations 5 and 6 are equivalent to the Kennedy correlations (Eqns 4 to 6). The critical velocity thus calculated would therefore correspond to a fire located just inside the cross-passage door-frame, i.e. a 'worst case' scenario. With increasing longitudinal flow in the tunnel, the hot gases in the tunnel would be cooled down, hence their density (\mathbf{r}_f) would rise. This effect reduces the critical velocity through the cross-passage V_d in Eqn. 6.

Numerical Example

A brief numerical example will demonstrate the hypothesised relationship.

C_p	= 1040 J/(kg K)	T	= 300 K
Q_c	= 20×10^6 W	ρ	= 1.1 kg/m ³
grade	= 0%	A_d	= 4.4 m ²
A_T	= 33 m ² (tunnel annulus area)	H_d	= 2.2 m

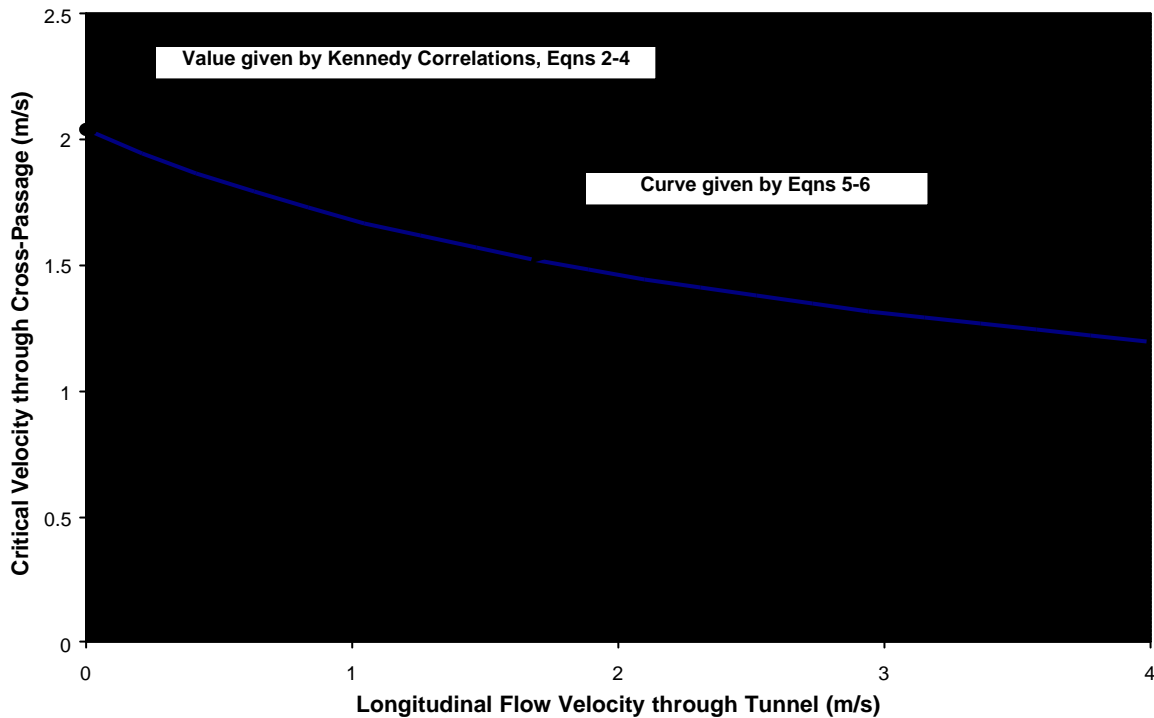

Fig. 4: Variation of Critical Velocity through a Cross-Passage with Longitudinal Tunnel Flow (Example)

Fig. 4 shows the critical velocity through a cross-passage would be significantly reduced with increasing longitudinal flow through the tunnel. This would imply that tunnel ventilation designers have a choice of different strategies for controlling smoke propagation across parallel tunnel tubes or within stations:

- *either* increase the longitudinal tunnel flow to cool the hot gases while maintaining a small cross-passage flow velocity, *or*
- ensure a strong cross-passage velocity, when the longitudinal tunnel velocity is small or cannot be controlled.

The first strategy has the added benefit of controlling smoke within the vehicle tunnel as well as within the cross-passage, as long as the airflow within the vehicle tunnel exceeds the required critical velocity. On the other hand, the generally large cross-sectional areas of the vehicle tunnel means that high longitudinal ventilation flowrates may be required. The second strategy is by definition a more robust strategy for controlling the smoke spread through a cross-passage, since no assumption is made regarding the longitudinal tunnel velocity. In practice however, the choice of emergency ventilation strategy is intimately related to the escape paths chosen (e.g. along the platform, through cross-passage doors, up escape staircases) and hence has to be carefully evaluated for each project.

Assumptions and limitations of model

An empirical model for the critical velocity as presented by Eqns. 5-6 has many assumptions and limitations that the reader should be aware of, in addition to those mentioned for the original Kennedy correlations in section 4.

- The hot smoke is assumed to fully mix with the longitudinal tunnel flow before reaching the cross-passage door. This in turn implies that the fire is located upstream of the cross-passage. Fires that are *downstream* of the cross-passage are unlikely to be the most critical in terms of smoke ingress into the cross-passage.

- The door height, H_d , is used as the relevant length scale in the definition of the Froude number (Eqn. 6). For the limit of zero longitudinal flow through the tunnel, this choice of length scale produces a critical velocity that is consistent with Kennedy's correlations.
- The empirical model neglects all instationary effects. In a real fire scenario, vehicle traffic flow changes rapidly and the emergency ventilation fans would be put into action, leading to highly instationary conditions.

Use for preliminary design

For practical engineering purposes, a 'worst-case' estimate of the required critical velocity through a cross-passage can be obtained for preliminary design purposes by

- Assuming no longitudinal flow through the tunnel, i.e. $\dot{m}_T = 0$;
- Setting the *convective* heat release rate of the fire \dot{Q}_c equal to the *total* expected heat release rate.

The net effect of these two assumptions is to provide a critical flow velocity and emergency fan capacities that are somewhat conservative. After development of the overall emergency ventilation concept, further optimisation may be carried out using CFD to check and confirm the preliminary estimates.

6 COMPUTATIONAL FLUID DYNAMICS

A limited CFD study was undertaken to investigate whether the results from the correlation for the critical velocity (Eqns. 5-6) are tenable. A section of a rescue station in the Gotthard Base Tunnel was modelled in the CFD analysis, as indicated in Fig. 5.

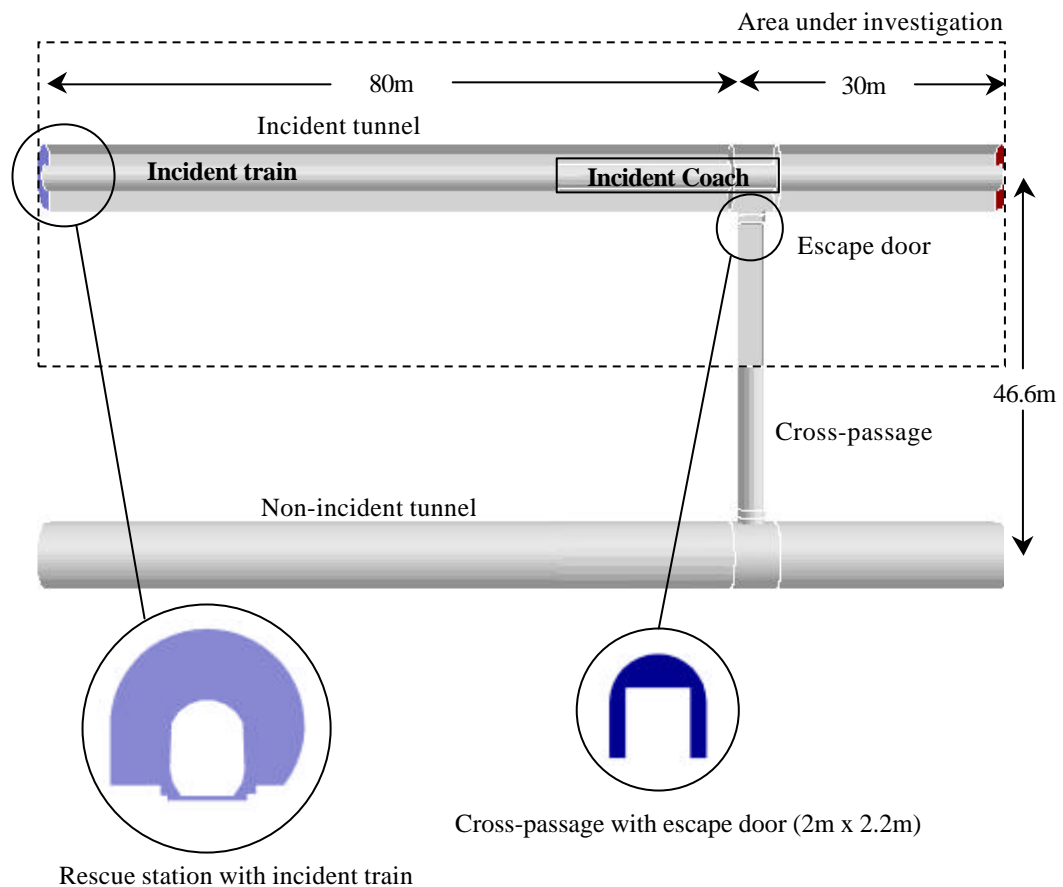

Fig. 5: Geometrical Model of Rescue Station with an Incident Train

As a first step, the CFD model (mesh, boundary conditions and physical models of heat transfer and turbulence) was tested for the case of a 10 MW train fire with no flow through the cross-passage. Fig. 6 indicates that a good agreement between the CFD computations and the Kennedy formula for the critical velocity was obtained.

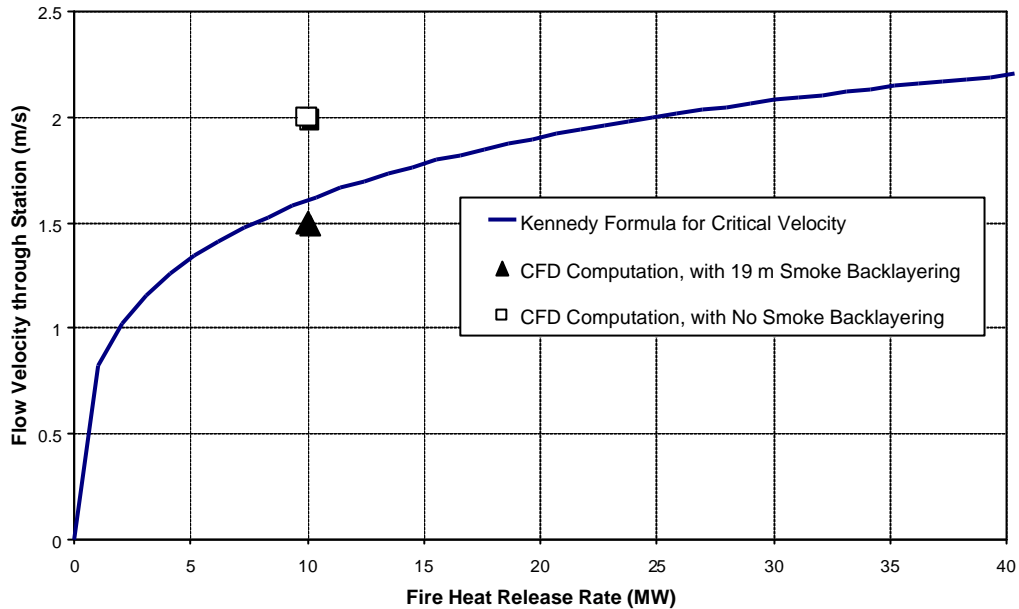

Fig. 6: Critical Velocities in Station Tunnel

The behaviour of the smoke within the tunnel was then analysed using a range of longitudinal velocities through the rail tunnel and through the cross-passage, and using two fire heat release rates (Fig. 7).

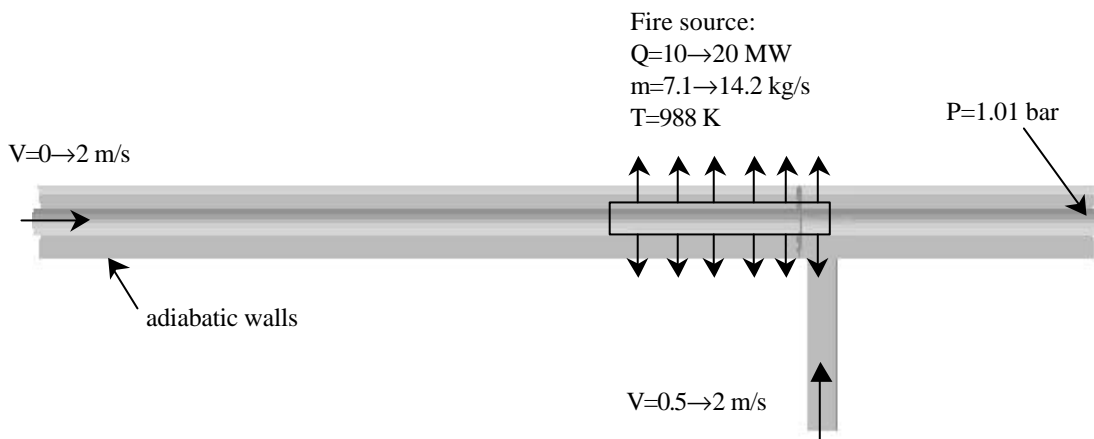

Fig. 7: External Boundary Conditions Applied to the CFD Model

Of particular interest in the calculations was to investigate the conditions under which smoke ingress into the cross-passages may occur (Fig. 8). Summary diagrams were produced for each fire heat release rate comparing the results of the CFD predictions of smoke ingress with the critical velocities

predicted by the correlations (Fig. 9). The results are in agreement which each other, which gives some confidence in the use of the proposed correlation of critical velocity in a cross-passage.

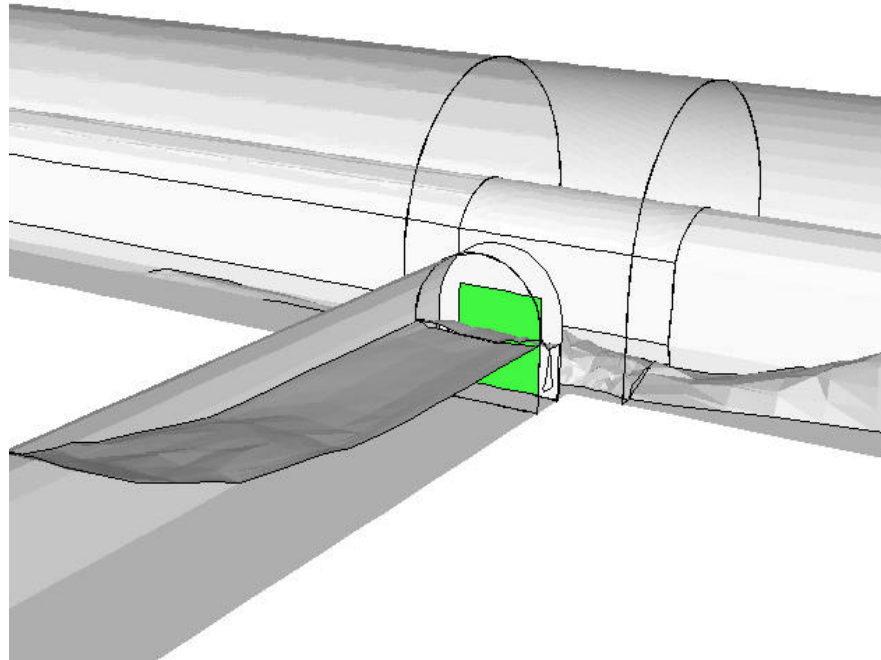

Fig. 8: Smoke Contaminates 14 m of a Cross-Passage for the Case of No Imposed Longitudinal Flow through the Station Tunnel, 2 m/s through Escape Door, 10 MW Fire.

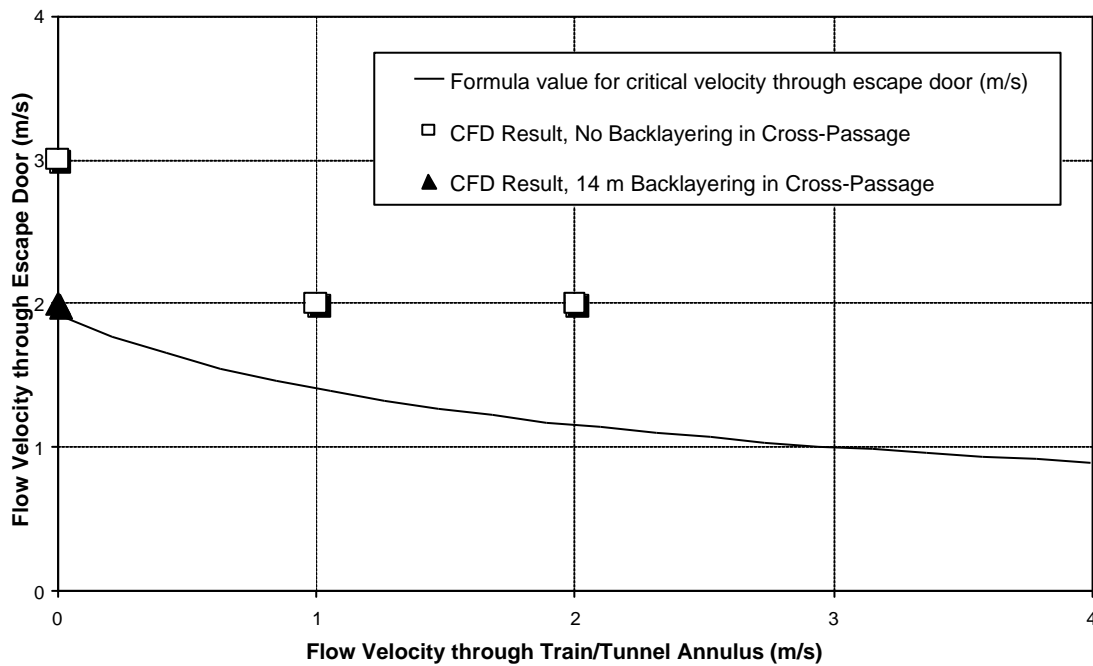

Fig. 9: Variation Of Critical Velocity through a Cross-Passage with Longitudinal Tunnel Flow using CFD and Formula (Eqns. 5-6) for a 10 MW Fire

7 CONCLUSIONS

The maintenance of smoke-free conditions in evacuation cross-passages is an important safety goal, and engineering correlations such as the ones discussed here, despite their many limitations, serve to

- highlight the importance of parameters such as cross-passage door geometry and longitudinal flow through the tunnel during the early design stage, and
- provide a first estimate of the flow velocity needed to protect the evacuation cross-passages, and hence deduce the required emergency fan capacity.

The use of properly validated Computational Fluid Dynamics (CFD) models can provide deeper insights into the probable behaviour of smoke in complex three-dimensional tunnel geometry (tunnels, stations, cross-passages, escape doors etc.). In this study, CFD was used to confirm the trends suggested by the simple engineering correlations. In general, CFD can also be used to check certain design points that are identified by the tunnel ventilation designer as being critical.

8 REFERENCES

- Channel Tunnel Safety Authority (1997) *Inquiry into the fire on heavy goods vehicle shuttle 7539 on 18 November 1996*, The Stationery Office, UK.
- Charters, D.A., Gray, W.A. and McIntosh, A.C. (1994) A computer model to assess fire hazards in tunnels (FASIT), *Fire Technol.* 30, pp. 134-154.
- Grant, G.B., Jagger, S.F. and Lea, C.J. (1998) "Fires in tunnels", *Phil. Trans. R. Soc. London A*, 356, pp. 2873-2906.
- Kennedy, W.D. (1996) "Critical Velocity : Past, Present and Future", One Day Seminar on Smoke and Critical Velocity in Tunnels, ITC, 2 April.
- Lee, C.K., Hwang, C.C., Singer, J.M. und Chauken, R.F. (1979) "Influence of Passageway Fires on Ventilation Flows", Second International Mine Ventilation Congress, Reno, Nevada, 4-8 November.
- National Fire Protection Association (1996) *NFPA 92A, Recommended practice for smoke-control systems*.
- National Fire Protection Association (1993) *NFPA 105, Installation of smoke-control door assemblies*.
- Thomas, P.H. (1970) "Movement of smoke in horizontal corridors against an air flow". *Inst. Fire Engrs Q.* 30, pp. 45-53.
- Tuovinen, H. and Holmstedt, G. (1994) "CFD Modelling of Tunnel Fires", International Conference on Fires in Tunnels, Boras.